

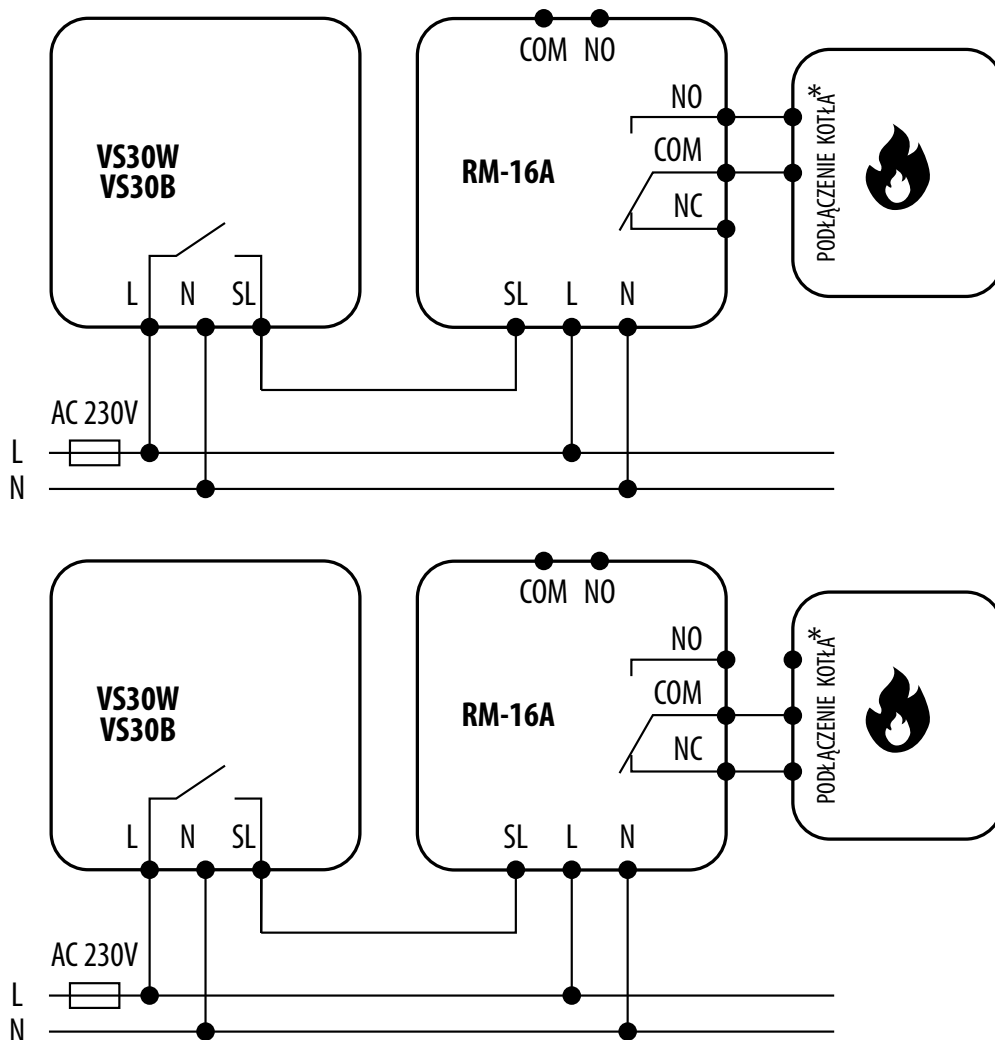















VS30W+RM-16A - Schemat podłączenia.



LEGENDA

	Zasilanie bateryjne		Komunikacja bezprzewodowa
L, N	Napięcie zasilania 230V AC		Pompa
	Bezpiecznik		Siłownik zaworu
COM, NO, NC	Styki beznapięciowe wyjściowe		Czujnik temperatury
S, S1, S2	Oznaczenie wejścia		Wentylator 3-biegowy 230V AC
SL	Wyjście napięciowe 230V AC		Żarówka lub inne obciążenie
	Styk normalnie otwarty (zwierany)		Siłownik termoelektryczny
	Styk normalnie zamknięty (rozwierany)		Programator czasowy
	Styk przełączny NC/COM/NO		Zewnętrzny styk zwierany
	Kocioł - Podłączenie kotła* - Styki w kotle do podłączenia regulatora ON/OFF (wg instrukcji kotła)		Transformator